



NanoJet Series User Manual

Chemyx Inc.
10905 Cash Road
Stafford, TX 77477 USA

www.chemyx.com

Intellectual Property All Intellectual Properties, as defined below, owned by or which is otherwise the property of Chemyx Inc. or its suppliers relating to the Chemyx syringe pumps, including but not limited to, accessories, parts or software relating thereto (Chemyx Syringe pumps), are proprietary to federal and state laws, and international treaty provisions. Intellectual Property includes but is not limited to, inventions (patentable or unpatentable), patents, trade secrets, copyrights, software, firmware, computer programs, and related documentation and other works of authorship. Moreover, you agree that you will not, and will not attempt to, modify, prepare derivative works of, reverse engineer, disassemble the Chemyx syringe pumps, decompile or otherwise attempt to create source code from the related software/firmware. No title to or ownership in Intellectual Property is transferred to you. All applicable rights of the Intellectual Property shall remain with Chemyx and its suppliers.

EU Declaration of Conformity (DoC)

We:

Chemyx, Inc.
10905 Cash Road
Stafford, TX 77477
(281) 277-5499
sales@chemyx.com

declare that the DoC is issued under the sole responsibility of the manufacturer and belongs to the following product(s):

All Syringe Pump Products, including:

- **Fusion 100**
- **Fusion 200**
- **Fusion 400**
- **Nexus 3000**
- **Nexus 6000**
- **NanoJet StereoTaxic**

The object of the declaration described above is in conformity with the relevant Union harmonization legislation:

- **EMC Directive 2004/108/EC (until April 19, 2016) and Directive 2014/30/EU (from April 20, 2016).**
- **LV Directive 2006/95/EC (until April 19, 2016) and Directive 2014/35/EU (from April 20, 2016).**
- **Directive 2011/65/EU of the European Parliament and of the Council of 8 June 2011 on the restriction of the use of certain hazardous substances in electrical and electronic equipment.**

The technical documentation required to demonstrate that the products meet the requirements of the LV and EMC directives has been compiled and is available for inspection by the relevant enforcement authorities.



Signature on behalf of manufacturer:

Authority:

Date:

Jeff Wu, Senior Engineer, Chemyx, Inc.

January 1, 2016

Attention!

The attention of the specifier, purchaser, installer, or user is drawn to special measures and limitations to use which must be observed when these products are taken into service to maintain compliance with the above directives.

Details of these special measures and limitations to use are available on request,
and are also contained in the product manuals.

Table of Contents

Manual Description	5
Limited Warranty	5
Repairs	5
Dead Pixel Policy	6
Serial Number	6
Calibration	6
Operational Safety	7
Technical Specifications	8
Principle of Operation	9
Pump Features	10
Keypad	10
LCD Screen	10
Syringe Clamps	10
Safety Nut	10
Power and Fuse	11
TTL Port	11
Serial Port	11
Alarms	12
Stall Detection	12
Modes of Operation	12
Keypad Interface	13
Navigation Controls	
Pump Controls	
Numeric keypad controls	
Operating Instructions	14
Syringe Loading	
Running the Pump Interface	
Pump Maintenance	16
Computer Control (RS232 Operation)	17
Cable Requirements	17
RS232 Port Settings	18
RS232 Communication Protocols	19
Testing Communication in HyperTerminal	19
USB to RS232 Dongle Converters	19
TTL, Daisy Chaining, Chemyx Software	20
Appendices	21
Fuse Replacement	21

Manual Description

This Manual covers the basic operational elements and usage of Chemyx syringe pumps. This does not include all aspects of usage or OEM /custom designed systems that are fabricated by Chemyx for other companies. Chemyx does not directly support OEM systems unless otherwise specified.

Limited Warranty

Chemyx warrants its products against defects in materials and workmanship for a period of one year from the shipment date. Chemyx will repair any product that proves defective during its stated warranty period.

The foregoing warranty will not apply to effects resulting from:

- Improper or inadequate maintenance or operation
- Unauthorized modification or misuse of the product
- Operation outside the electrical specifications for the product
- Operation outside the temperature specifications for the product
- User-induced internal and external contaminations of the instrument
- Failure to use proper surge protection
- Improper product return, packaging, and shipping
- Removing serial number from syringe pump.

Contact either by e-mail or phone Chemyx Inc. before returning a product. Chemyx will issue a Return Authorization (RA) number.

Return products to:

Chemyx Inc.
10905 Cash Road
Stafford, TX 77477 USA

Repairs

Chemyx can repair any syringe pump without major damage. You must contact either by e-mail or phone Chemyx Inc. before returning a product. Chemyx will issue a Return Authorization (RA) number to you.

Return products to:

Chemyx Returns
10905 Cash Road
Stafford, TX 77477 USA

Dead Pixel Policy

During the LCD Monitor manufacturing process, it is not uncommon for one or more pixels to become fixed in an unchanging state. The visible result is a fixed pixel that appears as an extremely tiny dark or bright dot. In almost every case, these fixed pixels are hard to see and do not detract from display quality or usability. A display with a few bright or dark dots is considered normal and within industry standards.

Serial Number

The serial number is located on the back top left corner or center of the pump under a small barcode. Removal of the serial number label voids your warranty.

Calibration

Chemyx Pumps are pre-calibrated upon arrival to your site. All calibrated parameters are within stated accuracy and precision specifications of the pump. Although the pump might be highly accurate different syringes have much greater error from Glass at 1% to Plastic at 5% error. Chemyx is not responsible for errors generated from syringes.

Operational Safety

Please read the following safety precautions to ensure personal safety and operational longevity of the Chemyx syringe pump. Chemyx, Inc. is not responsible for the equipment if used in a manner not specified by the manufacturer; warranty coverage provided by the equipment may be dropped as a result.

CHEMYX PRODUCTS ARE NOT FOR USE ON HUMANS

USE PROPER POWER SUPPLY

Chemyx Inc is not responsible for the use of power supplies outside the stated electrical specifications or failure to switch the power converter from 240V to 120V while in the 240V environment or vice versa.

GROUND PRODUCT

Proper grounding is required.

DO NOT OPEN THE PUMP

Warranty coverage will be dropped if the pump is opened without authorization from Chemyx. Do not touch any electric connectors on the product.

DO NOT OPERATE WITH SUSPECTED FAILURES

Even though the pump can operate at extremely fast speeds, the user must determine the proper flow rate for any given application. For instance, pumping at 90ml/min using a 20 gauge needle will cause stalls and/or potential bursting of the syringe. Chemyx is not responsible for any damage that might result from examples similar to above.

PINCH HAZARD

Do not place fingers between the pusher block and end block while the pump is running.

OBSERVE ALL WARNING LABELS ON PRODUCT

Read all labels on product to ensure proper usage.

CHEMYX IS NOT RESPONSIBLE FOR SYRINGE DAMAGE

It is the user's responsibility to wet ground glass syringes and set / tighten the safety nut appropriately for microsyringes.

Technical Specifications

Note: The step resolution stated is the minimum step resolution achieved by a pump.

NanoJet	
Syringe size	0.5 microliter to 1 milliliter
Voltage operating range	115V~240V, 0.25 A, 55-60 Hz
Drive mechanism	Stepper motor
Step resolution (advance per microstep)	0.135 $\mu\text{m}/\text{step}$
Flow rate range	0.001 $\mu\text{l}/\text{hr}$ (10 μl) to 1ml/min
Nominal linear force	15 lbs
Dimensions	6.5 in x 9.5 in x 3 in
Weight	6.0 lbs
Temperature range	10°C ~ 50°C
Humidity	20% - 80% RH
RS232 Connector	D9 Sub-connector
TTL Connector	USB-B Receptacle

Principle of Operation

All Chemyx syringe pumps are driven via a stepping motor that drives a lead screw and Pusher Block. The resulting action ejects fluid from the barrel of a syringe.

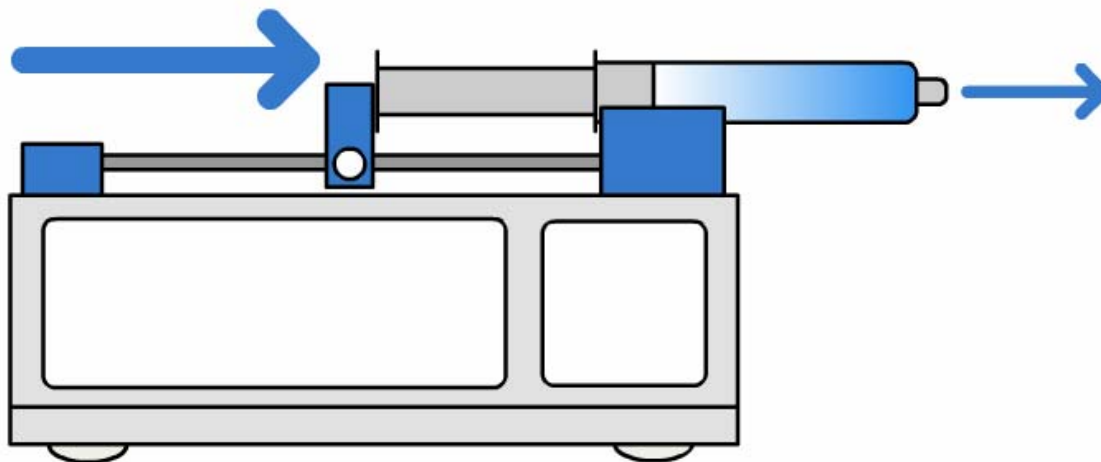

*When withdrawing, the operation is the same with only the motor reversing direction.

Pump Features

The Nanojet model works off the same principle. However, this model features one or more pump headers that can be detached and controlled separately from the control box via a RS232 cable.

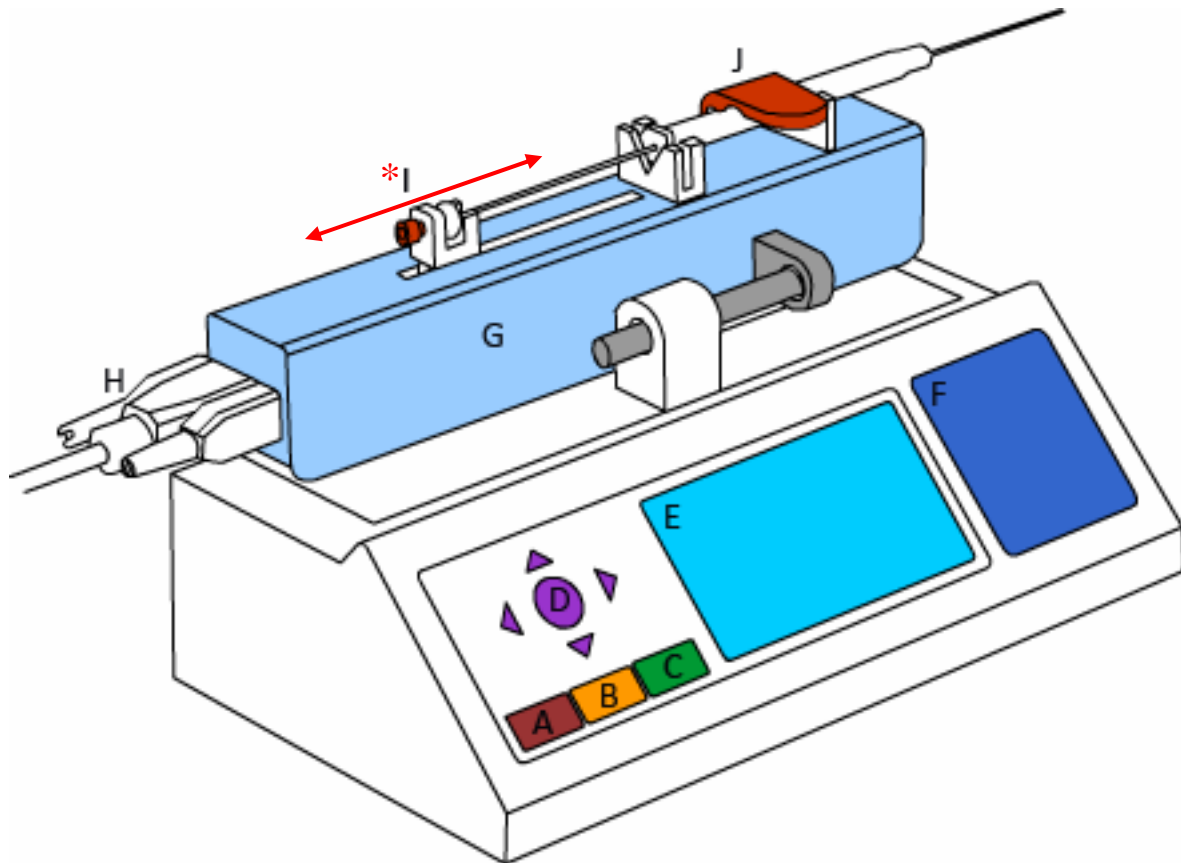

- A: Stop button
- B: Pause button
- C: Start button
- D: Directional keypad
- E: LCD screen
- F: Numeric keypad
- G: Pump header
- H: RS232 header connection port
- I: Push/pull block *Bottom screw of pusher block is where adjustments are made to accommodate and lock in various syringe sizes*
- J: Syringe holder clamp

Features continued

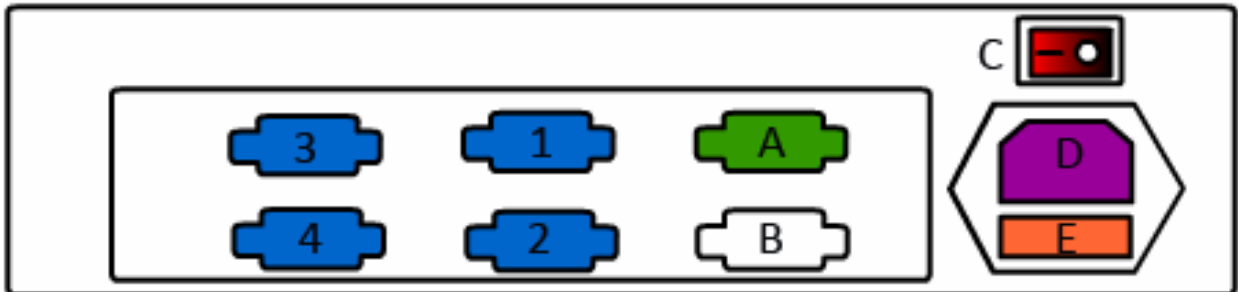

1-4 Pump head module RS232 connection ports

- A: active RS232 port for PC control
- B: Inactive
- C: Power on/off switch
- D: Power Plug
- E: Replacement/spare fuse

Features continued

Alarms

Audible Alarms will sound in case of a stall and on power on.

Stall Detection

Stall detection occurs when an optical detector used in verifying expected movement of the motor detects jamming or excessive pressure.

In the case of severe stalls from corroded guide rods, the mechanical locking nut will decouple and unlock the pusher block

Modes of Operation

Infuse:

Pump runs continuously ejecting fluids from a syringe until stopped.

Withdraw:

Pump runs in the reverse direction until stopped.

Keypad Interface

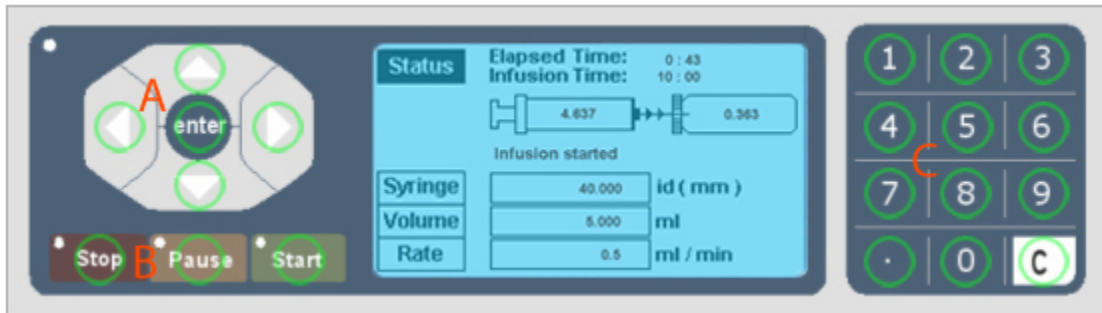

The green circles represent depressible buttons on the membrane surface.

A) Navigation controls

The navigation key pad is for tabbing between inputs on the interface. Once an input has been selected the enter button is used to confirm the input to memory.

B) Pump controls

The pump controls are used for starting pausing and stopping the pump. If any input is out of the pump's range, the pump will not start.

C) Numeric Keypad Controls

The numeric keypad is for entering inputs into the available data entry boxes. The C in the bottom right corner clears an input box if an error has been made in entry.

Operating Instructions

Syringe Loading

Place the syringe into the V shaped slot by lifting the spring clamp. Loosen or tighten push/pull block screw to secure syringe in place.

Connect header(s) before powering pump on

Pump control box must be powered off before switching CAT5 cable between different pump head module ports. Changing an active pump head module between power jacks (one, two, three, or four) while pump is on will result in:

- a) System will not recognize header
- b) Pump header will short out

Running the Pump Interface

- 1) When power is on, the system will show the startup screen.



- 2) After the startup screen, a home screen with four sections, one for each pump module will appear. Assuming the modules are not yet connected, each square will read "Pump Module Disconnected / Connect to Activate." Once the pump module is connected, the window will read "Pump stopped / Total volume 0.000000."

Pump Module 1 Current Operation: Pump Running Infused Volume: 0.02457 ml Set Pump Status	Pump Module 2 Current Operation: Pump Stopped Infused Volume: 1.00000 ml Set Pump Status
Pump Module 3 Current Operation: Pump Paused Infused Volume: 0.05673 ml Set Pump Status	Pump Module 4 Current Operation: Pump Module Disconnected Connect To Activate Set Pump Status

3) Using the keypad, toggle to each of the pump head data input screens. The selected input box will highlight in orange. There are two options within each pump head module input box: "Set Pump" and "Status."

A)

Pump Module 1 Current Operation: Pump Running Infused Volume: 0.02457 ml Set Pump Status	Pump Module 2 Current Operation: Pump Stopped Infused Volume: 1.00000 ml Set Pump Status
Pump Module 3 Current Operation: Pump Paused Infused Volume: 0.05673 ml Set Pump Status	Pump Module 4 Current Operation: Pump Module Disconnected Connect To Activate Set Pump Status

B)

Pump Module # 1			
Syringe	0.5678	ID(mm)	Find Syringe
Volume	0.25	ml	
Rate	0.002	ml/min	Change Units
Delay	5	min	Back
Max Rate: 10.000000 Min Rate: 0.00000001			

Within "Set Pump" option user can enter any parameter by using the navigation keys to tab between input options (Syringe, volume, rate, delay).

C)



Standard Infusion			
Syringe	0.5678	ID(mm)	Find Syringe
Volume	0.25	ml	→ Infuse
Rate	0.002	ml/min	Change Units
Delay	5	min	Back
Max Rate: 10.000000 Min Rate: 0.00000001			

When ready to start the pump, press "start" on the keypad.



4) Pumps will continue to operate if users go back to the home screen. From there, start the operation or monitor the status of other pump head modules. A pump in operation will show its status on this screen. Start, stop, and pause pump operations can be managed from the home screen.

Pump Module 1 Current Operation: Pump Running Infused Volume: 0.02457 ml Set Pump Status	Pump Module 2 Current Operation: Pump Stopped Infused Volume: 1.00000 ml Set Pump Status
Pump Module 3 Current Operation: Pump Paused Infused Volume: 0.05673 ml Set Pump Status	Pump Module 4 Current Operation: Pump Module Disconnected Connect To Activate Set Pump Status

A) If the parameter is out of bounds, the pump will show an "effective range" screen for the max and min values at the center of the page. Pump will display "pump running-infusion mode" or "pump running-withdraw mode," based upon the function entered in module "set pump" screen. Once pump has completed running, screen will display, "Pump run finish."



Pump 1	Elapsed Time 00 : 21 : 00 Infusion Time 00 : 04 : 30
	 0.237994 → 2.369492
	Pump Running
Syringe	5.89 mm
Volume	0.60000 ml
Rate	0.0450000 ml/min
	Back

B)

Pump 1	Elapsed Time 10 : 00 : 00 Infusion Time 00 : 00 : 00
	 1.237994 → 2.369492
	Pump Stopped
Syringe	5.89 mm
Volume	2.60000 ml
Rate	6.600000 ml/min
	Back

C)

Pump 1	Elapsed Time 10 : 00 : 00
	Infusion Time 00 : 00 : 00





Pump Paused

Syringe	5.89	mm
Volume	2.60000	ml
Rate	6.600000	ml/min

Back

D)

Pump 1	Elapsed Time 10 : 00 : 00
	Infusion Time 00 : 00 : 00



Pump Stalled

Syringe	5.89	mm
Volume	2.60000	ml
Rate	6.600000	ml/min

Back

Pump Maintenance

Chemyx pumps require limited maintenance that can be performed with minimal downtime and effort. Proper maintenance of pump will ensure the system's operating life to over 5 years. On a routine basis, the following procedures should be followed:

Oil your system:

1. Apply motor oil or machine oil to the lead screw and guide rod. This should be performed once **every 4 months** to maintain optimal lubrication.
2. Clean contact surfaces and debris. Take care to remove any debris on the lead screw and guide rods.

Consistent oiling of your pump will protect the pump from oxidizing fumes in fume hoods and extend the pumps performance and operating life many years.

Approved Lubricants:

Engine oil or Motor oil – any type
Silicone oil
Machine oil
Tooling oil or "WD-40"

Contact Chemyx if you wish to use other lubricants.

Signs that your system is not adequately lubricated:

- 1) Grinding sounds coming from the lead screw.
- 2) Locking nut is decoupling under load before stall
- 3) Slow decrease of max pushing force.

Computer Control (RS232 Operation)

Cable Requirements

In order to interface to a PC you need the following hardware cable pictured below:



DB9 Serial Cable Male to Female – Straight through configuration. Do not purchase a "Null Modem," "crossover," or "crossed over" cables.

RS232 Port Settings

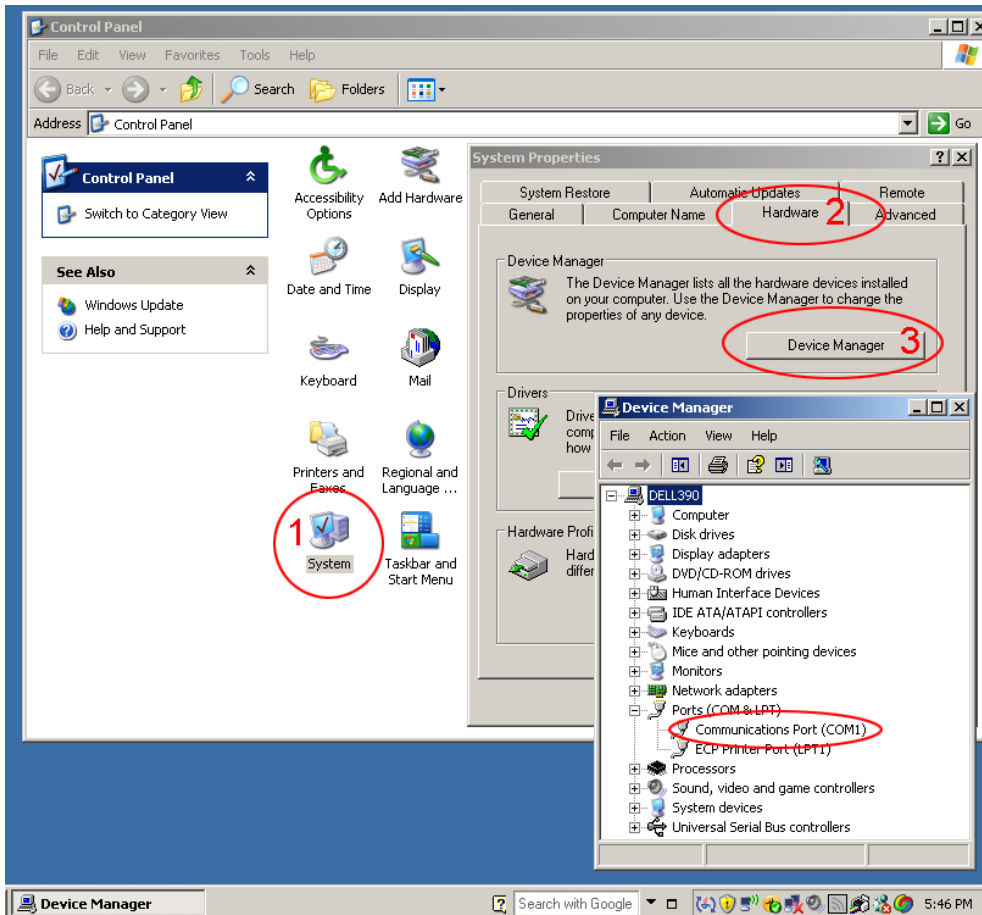

Before interfacing with a PC, make sure a RS232 port exists on your PC. RS232 ports will be in parentheses and named "COM1-100" like the one above named COM1

RS232 Port Settings (continued)

Baud Rate - 9600, Data Bits - 8, Parity - none, Stop bits - 1, Flow control – none.

Most programming packages like LabView, LabWindows and Visual Studio will allow you to program comport settings dynamically in program.

RS232 Communication Protocols

<u>Protocols:</u>	<u>Resulting Action by Pump</u>
help	- Show help information
stop	- Pump Stop
pause	- Pump Pause
start	- Pump Run
status	- Pump Return Status
set units [xxx]	- Pump Set units
set diameter [x.x]	- Pump Set diameter
set rate [x.x]	- Pump Set rate
set time [xxx]	- Pump Set time@volume
set volume [x.x]	- Pump Set volume
set delay [xxx]	- Pump Set delay@start
save setting	- Pump parameter saved
read limit parameter	- Pump Returns Limit Parameter
view parameter	- Pump parameter settings
restart	- Pump restart

Example: "set volume 1.35" send the command to set the volume to 1.35.

Testing Communication in HyperTerminal

HyperTerminal is a Microsoft utility where users can manually enter in protocols one by one to get the pump to communicate. All Windows based PCs have the HyperTerminal utility. Located in START > Programs > Accessories > Communications > HyperTerminal

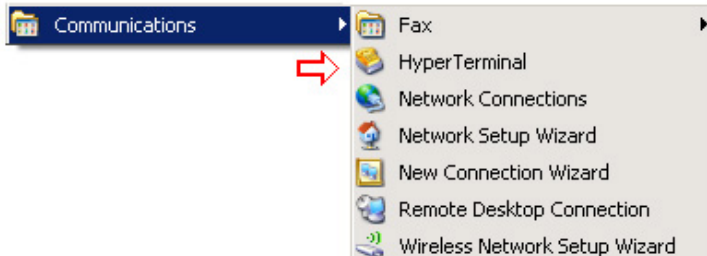

Click HyperTerminal to start the program. Configure the COM port with the following settings.

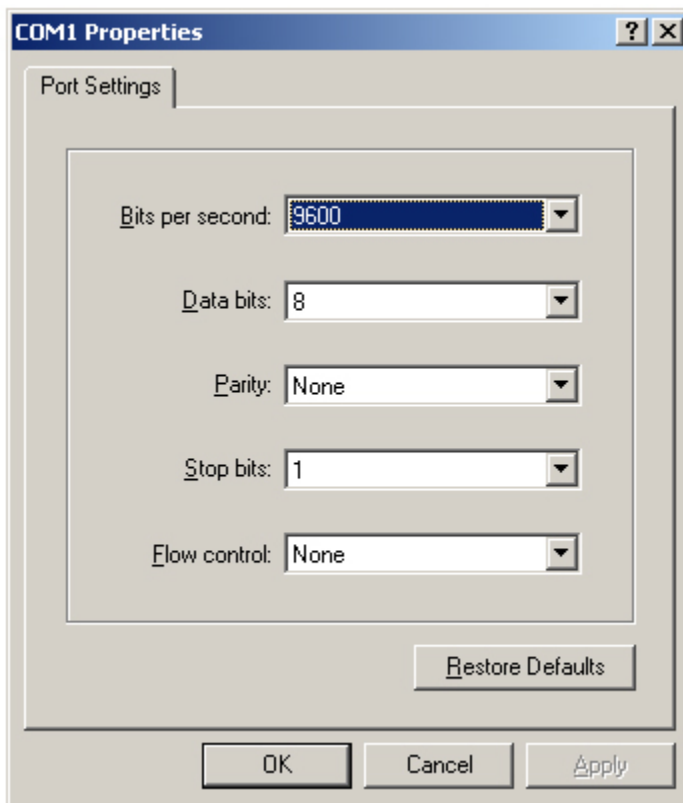

After you press OK you will come to a blank window with a blinking cursor. You can type in protocols here to test communication or to run the pump from a remote computer. Connect the pump to the PC. Type in "help" and then press enter to get a complete list of protocols available to the pump.

USB to RS232 Dongle Converters

Due to the large numbers of computers made without RS232 ports, USB to RS232 dongles have been popular to "emulate" a RS232 port. Most but not all USB to RS232 dongles work with chemyx pumps due to driver conflict issues.

TTL

TTL is a hold over from classical syringe pumps built in the 1970s before RS232 ports existed. However Chemyx does have a TTL port grandfathered in for triggering starts and stops. The TTL port has a USB-B receiver configuration.

TTL works with Chemyx's foot switch, hand switch or parallel switches.

Other

Multi pump control "Daisy Chaining"

Pumps can be daisy chained via a RS232 Y connector or parallel switches. Please contact chemyx for more details on daisy chaining pumps.

Appendices -A

Replacing The Fuse.

In the event of a power surge resulting from a lightning strike, plugging the pump into an incorrect voltage or other surge event, the fuse in the syringe pump will break. If the fuse breaks, no power will be supplied to the pump.

Chemyx syringe pumps come with a complimentary backup fuse inside the pump. Please follow the instructions below on how to access the fuse holder and replace a broken fuse.

Step 1: Locate the power plug on the back of the pump. The Fuse holder is located underneath the 3 prongs of the power plug.



Step 2: Remove the fuse holder from the power plug. There is a small indentation on the bottom edge of the power plug. A small coin or screwdriver may be needed to remove the fuse holder from the pump.

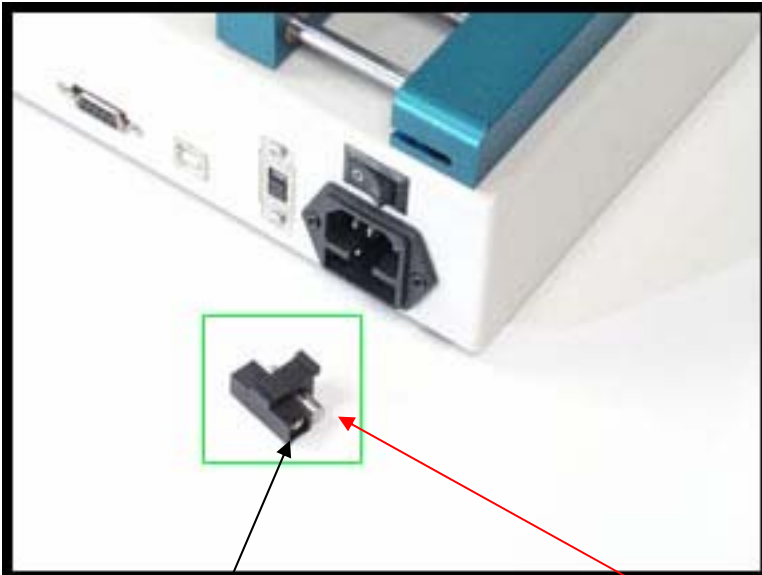
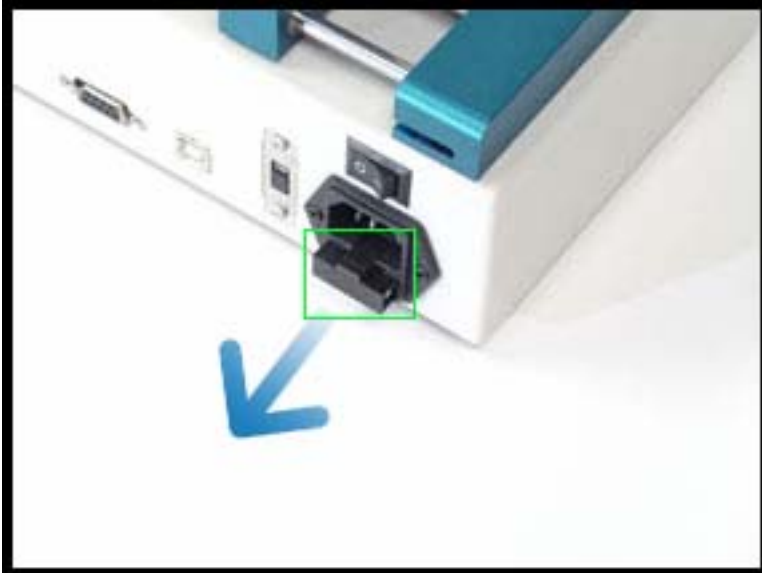

There are 2 fuses in the fuse holder. The exposed fuse in the back is the fuse that is being currently used. In the event of a power surge **this fuse will be the broken fuse.**

Step 4: Remove the broken fuse from the active slot in the holder. Most of the time and broken fuse will be visible to the naked eye.

Remove the **back-up fuse** from the plastic casing represented below by the check mark. Place the back-up fuse in the active slot. Insert the fuse holder back into the pump's power plug to reactivate the pump.

